

Specificatii tehnice



innovating health

Model PHS-S8

1. Specificatii tehnice
2. Dimensiuni
3. Intretinere

AUTOGNITY S.R.L.

Sede legale: Via del Popolo 6 - 05018 Orvieto (TR)
P.IVA. e C.F. 01608750558
Sede operativa: Via A. Manzoni 82, 06135 Ponte San Giovanni (PG)
Sede operativa: Via Carbonia 10, 56023 Navacchio (PI)
Tel.: +39 075 5093178, web: <http://www.autognity.com>,
email: info@autognity.com, info@pec.autognity.com

KLAIN ROBOTICS S.R.L.

Sede legale: Via Della Posta nr. 9 - 25122 Brescia
Sede operativa: Via Cacciamali , N° 67 - 25125 Brescia
Cod. Fisc. e P.I.V.A. 03219670985
Cap. Soc. 450.000,00 €
Telefono: +390303582154- Fax: +390302659911
<http://www.klainrobotics.com> - E-mail rgreco@klainrobotics.com

1. Specificatii tehnice

PHS-S8

Dimensiuni	
Inaltime	1378 mm
Diametru baza	450 mm
Greutate totala	60 kg
Culoare	Alb: RAL 9010
Putere	
Putere	AC 220 V, 50 Hz, 150 W max
Alimentare	Prin cablu
Durata de viata a bateriei	1 ora mod de lucru continuu
Durata de incarcare bateriei	3 ore
N° lampi	8
Dimensiuni lampi	diametru 15 mm, lungime 843 mm,
Putere lampi	41 W fiecare
Emisie UV la 254 nm	150 μ W/cm ² - 16 W
Mediu	
Domeniu temperatura	+5°C la 50°C (umiditate 10-95%).
Comunicare	
WiFi	Wireless banda dubla AC/G/N/B
4G	Incorporabil
Senzori de siguranta	
Scanner laser RPLEADAR A2	Scanare 360° (raza de actiune 18 m)
Camera Sony IMX322	Detectarea prezentei oamenilor



AUTOGNITY S.R.L.

Sede legale: Via del Popolo 6 - 05018 Orvieto (TR)
P.IVA. e C.F. 01608750558
Sede operativa: Via A. Manzoni 82, 06135 Ponte San Giovanni (PG)
Sede operativa: Via Carbonia 10, 56023 Navacchio (PI)
Tel.: +39 075 5093178, web: <http://www.autognity.com>,
email: info@autognity.com, pec@pec.autognity.com

KLAIN ROBOTICS S.R.L.

Sede legale: Via Della Posta nr. 9 - 25122 Brescia
Sede operativa: Via Cacciamali , N° 67 - 25125 Brescia
Cod. Fisc. e P.I.V.A. 03219670985
Cap. Soc. 450.000,00 €
Telefono: +390303582154- Fax: +390302659911
<http://www.klainrobotics.com> - E-mail rgreco@klainrobotics.com

2. Dimensioni

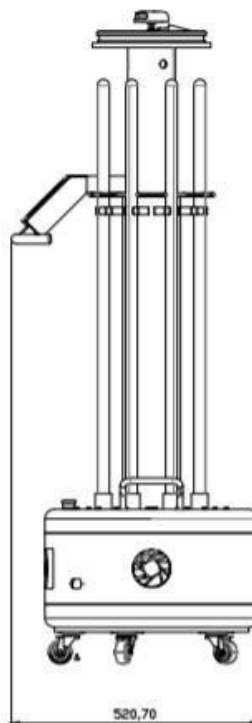
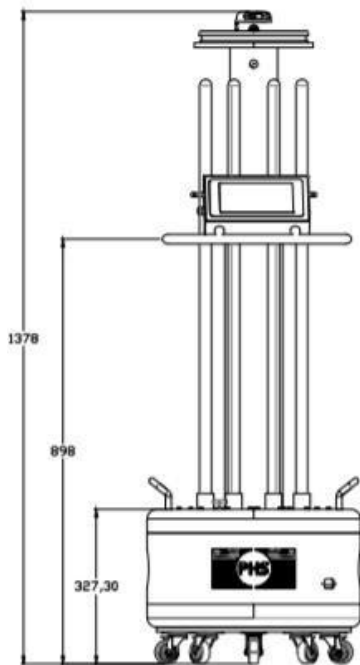
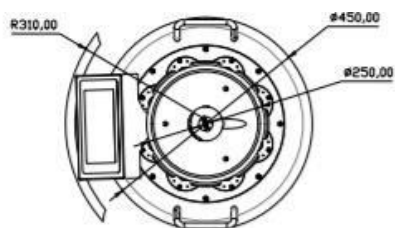

AUTOGNITY S.R.L.

Sede legale: Via del Popolo 6 - 05018 Orvieto (TR)
 P.IVA. e C.F. 01608750558
 Sede operativa: Via A. Manzoni 82, 06135 Ponte San Giovanni (PG)
 Sede operativa: Via Carbonia 10, 56023 Navacchio (PI)
 Tel.: +39 075 5093178, web: <http://www.autognity.com>,
 email: info@autognity.com, pec@pec.autognity.com

KLAIN ROBOTICS S.R.L.





Sede legale: Via Della Posta nr. 9 - 25122 Brescia
 Sede operativa: Via Cacciamali , N° 67 - 25125 Brescia
 Cod. Fisc. e P.I.V.A. 03219670985
 Cap. Soc. 450.000,00 €
 Telefono: +390303582154- Fax: +390302659911
<http://www.klainrobotics.com> - E-mail rgreco@klainrobotics.com

3. Intretinere

Urmatoarele instructiuni de intretinere ofera o imagine de ansamblu a modalitatii de curatare regulate si a procedurii de inlocuire a pieselor.

Intervalele declarate sunt indicative si depind de mediul de operare si frecventa de utilizare a echipmentului PHS.

Saptamanal: O data pe saptamana, efectuati urmatoarele sarcini de intretinere:

Piese	Sarcini de intretinere
Lampi	Curatati becurile cu o carpa umeda si un detergent slab.  Nu utilizati aer comprimat.
Masca si laterale	Curatati dispozitivul cu o carpa umeda si un detergent slab.  Nu utilizati aer comprimat.
Scanner laser	Clean the optics covers of the scanners for optimum performance. Use mild detergents.  Incarcarile statice determina ca particulele de praf sa fie atrase de capacul optic. Este posibil sa se diminueze acest effect prin utilizarea curatatorului anti-static din plastic si a carpii lentilelor SICK
Roti	Indepartati murdaria cu o carpa umeda si asigurati-va nu este nimic blocat intre roti.
Benzi de lumina LED	Verificati daca benzile de lumina LED sunt intacte.
Consola de comanda	Curatati afisajul cu o carpa umeda.  Nu utilizati aer comprimat. Nu utilizati detergenti puternici sau agresivi.

AUTOGNITY S.R.L.

Sede legale: Via del Popolo 6 - 05018 Orvieto (TR)
P.IVA. e C.F. 01608750558
Sede operativa: Via A. Manzoni 82, 06135 Ponte San Giovanni (PG)
Sede operativa: Via Carbonia 10, 56023 Navacchio (PI)
Tel.: +39 075 5093178, web: <http://www.autognity.com>,
email: info@autognity.com, pec info@pec.autognity.com

KLAIN ROBOTICS S.R.L.

Sede legale: Via Della Posta nr. 9 - 25122 Brescia
Sede operativa: Via Cacciamali , N° 67 - 25125 Brescia
Cod. Fisc. e P.I.V.A. 03219670985
Cap. Soc. 450.000,00 €
Telefono: +390303582154- Fax: +390302659911
<http://www.klainrobotics.com> - E-mail rgreco@klainrobotics.com